

DH-SD63120I-HC

1Mp 720P HDCVI PTZ Dome Camera



Features

- 20x optical zoom
- Max 50/60fps@720P resolution
- DWDR, Day/Night(ICR), Ultra DNR, Auto iris, Auto focus
- Control over coaxial cable, long distance real-time transmission
- Max 400°/s pan speed, 360° endless pan rotation
- Up to 255 presets, 5 auto scan, 8 tour, 5 pattern
- Built-in 2/1 alarm in/out
- Support intelligent 3D positioning with DH-SD protocol
- IP66

DH-SD63120I-HC

Technical Specifications

Model	DH-SD63120I-HC
Camera	
Image Sensor	1/3" Exmor CMOS
Effective Pixels	1280(H) x 960(V)
Scanning System	Progressive
Electronic Shutter Speed	1/1 ~ 1/30,000s
Min. Illumination	Color: 0.05Lux@F1.4; B/W: 0.005Lux@F1.4
S/N Ratio	More than 50dB
Resolution	720P(25/30/50/60fps)
Video Output	1-channel BNC HDCVI high definition video output
Camera Features	
Day/Night	Auto(ICR) / Color / B/W
Backlight Compensation	BLC / HLC / DWDR (Digital WDR)
White Balance	Auto, ATW, Indoor, Outdoor, Manual
Gain Control	Auto / Manual
Noise Reduction	2D/3D
Privacy Masking	Up to 24 areas
Digital Zoom	16x
Lens	
Focal Length	4.7mm~94mm(20x Optical zoom)
Max Aperture	F1.4 ~ F2.6
Focus Control	Auto / Manual
Angle of View	H: 54.1° ~ 3.2°
Close Focus Distance	100mm~ 1000mm
PTZ	
Pan/Tilt Range	Pan: 0° ~ 360° endless; Tilt: -2° ~ 90°, auto flip 180°
Manual Control Speed	Pan: 0.1° ~300° /s; Tilt: 0.1° ~250° /s
Preset Speed	Pan: 400° /s; Tilt: 300° /s
Preset	80(DH-SD), 255(Pelco-P/D)
PTZ Mode	5 Pattern, 8 Tour, Auto Pan, Auto Scan
Speed Setup	Human-oriented focal length/ speed adaptation
Power up Action	Auto restore to previous PTZ and lens status after power failure
Idle Motion	Activate Preset/ Pan/ Scan/ Tour/ Pattern if there is no command in the specified period
Time Task	Auto activation of Preset/ Pan/ Scan/ Tour/ Pattern by preset-time
Protocol	DH-SD, Pelco-P/D (Auto recognition)
Audio	
Interface	1 channel In
Auxiliary Interface	

DH-SD63120I-HC

RS485	1
Alarm	2/1 channel In/Out
General	
Power Supply	AC 24V/2.2A (±10%)
Power Consumption	9.5W, 21W (Heater on)
Working Environment	-40°C ~ 60°C / Less than 90% RH
Ingress Protection	IP66
Vandal Resistance	IK10
Dimensions	Φ222(mm) x 322(mm)
Weight	7.5kg

Dimensions (mm)

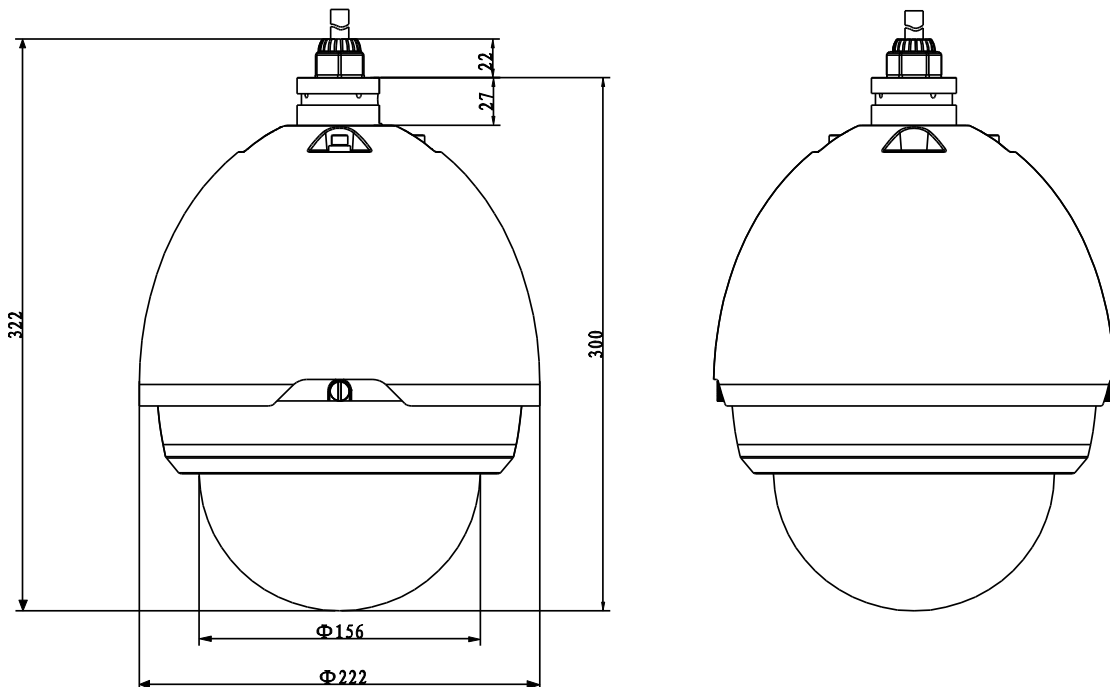









Accessories

	
DH-63FB	Power Supply

DH-SD63120I-HC

Accessories (Optional)

				
DH-PFA111	DH-PFB300C	DH- PFB301C	DH-PFA112	DH-PFA113

			
DH-PFB301S	DH-PFA120	DH- PFA150	DH-PFA151

Dahua Technology Co., Ltd.

1187 BinAn Road, Binjiang District, Hangzhou, China

Tel: +86-571-87688883

Fax: +86-571-87688815

Email:overseas@dahuatech.com

www.dahuatech.com

*Design and specifications are subject to change without notice.

© 2013 Dahua Technology Co., Ltd.